

FREMICA200 REMI

FREMICA200 -

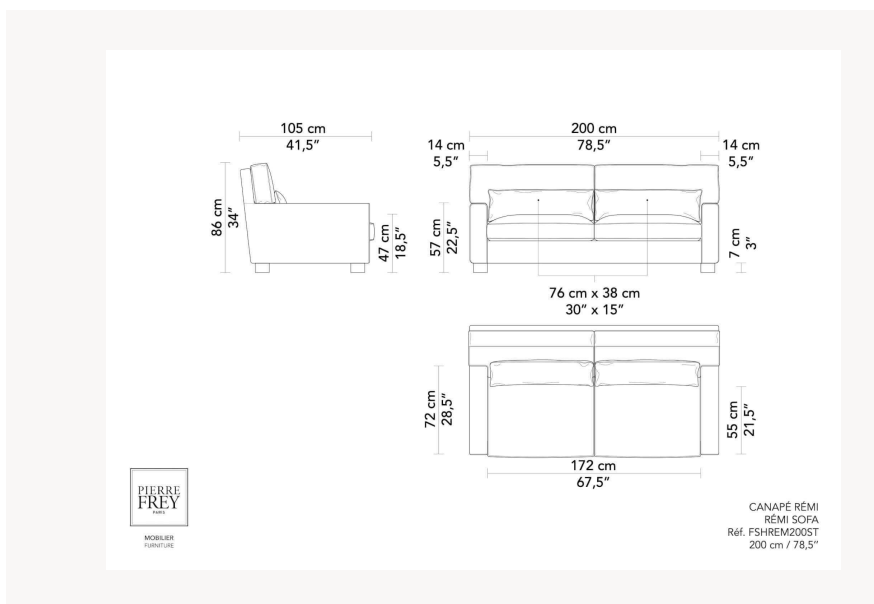

Pierre Frey

CATEGORY	Sofas
DESIGNER	Yves Halard
DIMENSIONS	L 78 x P 41 x H 33 inches
FRAME	Solid beech - Solid poplar Construction : Traditional assembly
COMFORT	Suspension : Springs Structure : wrapped in polyester wadding - HR foam 40 kg/m ³ Seat : Feathers - HR foam 35 kg/m ³ Back : HR foam 35 kg/m ³ - Feathers Cushion(s) : Goose feathers and down
FINISHES	Frame Finishes : Stained beech, water-based varnish Upholstery Finishes : Piping - Simple seams - Stretched fabric Cushion(s) Finishes : Simple seams - Piping
LEG FINISHES	Visible wood
INFORMATION	Cushions with removable covers and reversible
WEIGHT	183,06 Lbs
FABRIC QTY	16,84 yds

4 Colors



FREMICA

FREMICA200

FREMICA220

FREMICA250