

FVALLCA240B2 VALLON

The VALLON line offers refined harmony and a design of understated yet innovative sophistication. Its slipperchair and sofa embody timeless elegance with sensual shapes and bold curves. VALLON is distinguished by its double curvature and piping that also connects the backrest and seat, creating a fluid silhouette visible from every angle. The sculptural and inviting design embodies luxurious craftsmanship, pushing the boundaries of classical craftsmanship to offer an aesthetic that transcends time. Each piece is crafted with a meticulously worked wooden structure and multi-layer foam padding for exceptional comfort. In collaboration with Maison Pierre Frey, Christophe Delcourt expands the horizons of Pierre Frey Furniture's lines. This synergy highlights their mutual pursuit of a sensitive balance between modern allure and timeless design.

FVALLCA240B2 -

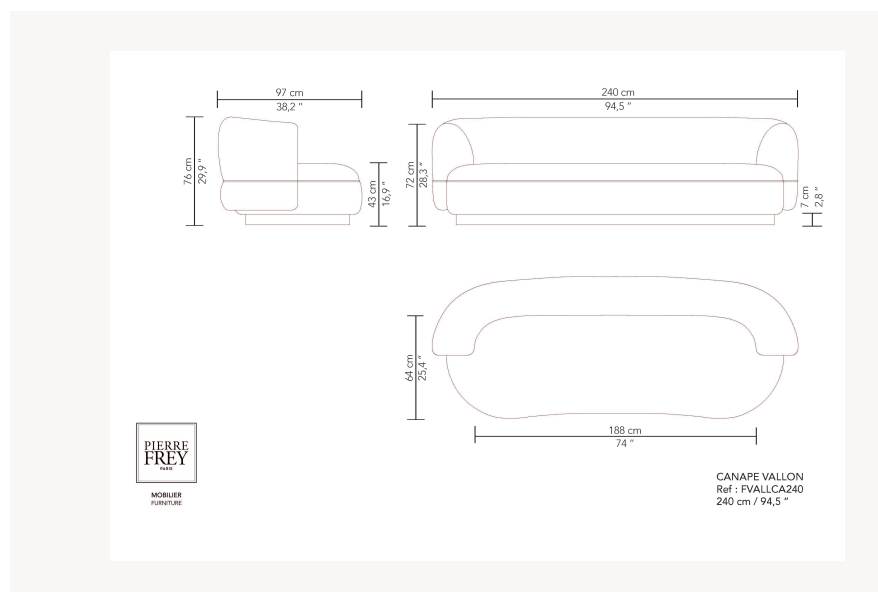

Pierre Frey

CATEGORY	Sofas
DESIGNER	Christophe Delcourt
DIMENSIONS	L 94 x P 37 x H 29 inches
FRAME	Wooden panel - Wood Construction : Traditional assembly
COMFORT	Suspension : Elastic webbing Structure : HR foam 35 kg/m ³ - HR foam 40 kg/m ³ - HR foam 30 kg/m ³ - HR foam 25 kg/m ³ Seat : HR foam 30 kg/m ³ - HR foam 25 kg/m ³ - HR foam 40 kg/m ³ - HR foam 35 kg/m ³ Back : HR foam 30 kg/m ³
FINISHES	Frame Finishes : Oiled bleached oak - Stained oak, water-based varnish - Brushed oak, stained with water-based varnish - Varnish oak Upholstery Finishes : Piping
LEG FINISHES	Wooden base - Visible wood - Upholstered - Metal base
INFORMATION	Refer to the exhaustive list of compatible fabrics
WEIGHT	231,58 Lbs
FABRIC QTY	10,86 yds
AVAILABLE OPTIONS	Metal base Upholstered base Oak base

12 Colors



FVALLCA200B
2SP

FVALLCA200M
1SP

FVALLCA200S
PE

FVALLCA220

FVALLCA220B
2

FVALLCA220M
1

FVALLCA240

FVALLCA240B
2

FVALLCA240M
1

FVALLCA260B
2SP

FVALLCA260M
1SP

FVALLCA260S
PE